

IMBOLD COM SRL

Str.Valea Cascadelor Expo Top Construct, sector 6,
Bucuresti, si Str.13 Decembrie Nr.140 Gaesti
Dambovita tel: 0757323528

www.centraleinstalatii.ro

GRUNDFOS INSTRUCTIONS

GRUNDFOS ALPHA2

Ⓒ Installation and operating instructions



Declaration of Conformity

We **Grundfos** declare under our sole responsibility that the products **GRUNDFOS ALPHA2**, to which this declaration relates, are in conformity with the Council Directives on the approximation of the laws of the EC Member States relating to

- Machinery (98/37/EC).
- Electrical equipment designed for use within certain voltage limits (2006/95/EC).
Standards used: EN 60335-1: 2002 and EN 60335-2-51: 2003.
- Electromagnetic compatibility (2004/108/EC).
Standards used: EN 61000-6-2 and EN 61000-6-3.

Bjerringbro, 1st June 2007

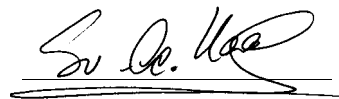

Svend Aage Kaae
Technical Director

CONTENTS

	Page
1. Symbols used in this document	4
2. General description	5
3. Applications	6
4. Installation	8
5. Electrical connection	11
6. Control panel	12
7. Setting the pump	14
8. Automatic Night SetBack	16
9. Systems with bypass valve between flow and return pipes	18
10. Start-up	20
11. Pump settings and pump performance	22
12. Fault finding chart	24
13. Technical data and installation dimensions	25
14. Performance curves	27
15. Features	33
16. Accessories	35
17. Disposal	36



Warning

Prior to installation, read these installation and operating instructions. Installation and operation must comply with local regulations and accepted codes of good practice.

1. Symbols used in this document



Warning

If these safety instructions are not observed, it may result in personal injury!



Caution

If these safety instructions are not observed, it may result in malfunction or damage to the equipment!



Note

Notes or instructions that make the job easier and ensure safe operation.

2. General description

Contents:

[2.1 The GRUNDFOS ALPHA2 circulator pump](#)

[2.2 Advantages of installing a GRUNDFOS ALPHA2.](#)

2.1 The GRUNDFOS ALPHA2 circulator pump

The GRUNDFOS ALPHA2 circulator pump is designed for the circulation of water in heating systems and domestic hot-water systems.

GRUNDFOS ALPHA2 is the best choice for

- underfloor heating systems
- one-pipe systems
- two-pipe systems.

GRUNDFOS ALPHA2 incorporates a permanent-magnet motor and differential-pressure control enabling continuous adjustment of the pump performance to the actual system requirements.

GRUNDFOS ALPHA2 has a user-friendly front-mounted control panel.

See [6. Control panel](#) and [15. Features](#).

2.2 Advantages of installing a GRUNDFOS ALPHA2

The installation of a GRUNDFOS ALPHA2 means

easy installation and start-up

- GRUNDFOS ALPHA2 is easy to install.
Thanks to the *AUTOADAPT* function (factory setting), the pump can, in most cases, be started without making any settings.

high degree of comfort

- Minimum noise from valves, etc.

low energy consumption

- Low energy consumption compared to conventional circulator pumps.
The GRUNDFOS ALPHA2 is A-labelled.

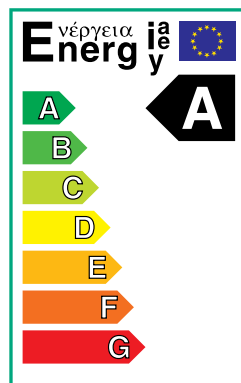

TM03 0868 0705

Fig. 1 Energy label, A-labelled

3. Applications

Contents:

- 3.1 System types
- 3.2 Pumped liquids
- 3.3 System pressure
- 3.4 Relative air humidity (RH)
- 3.5 Enclosure class
- 3.6 Inlet pressure.

3.1 System types

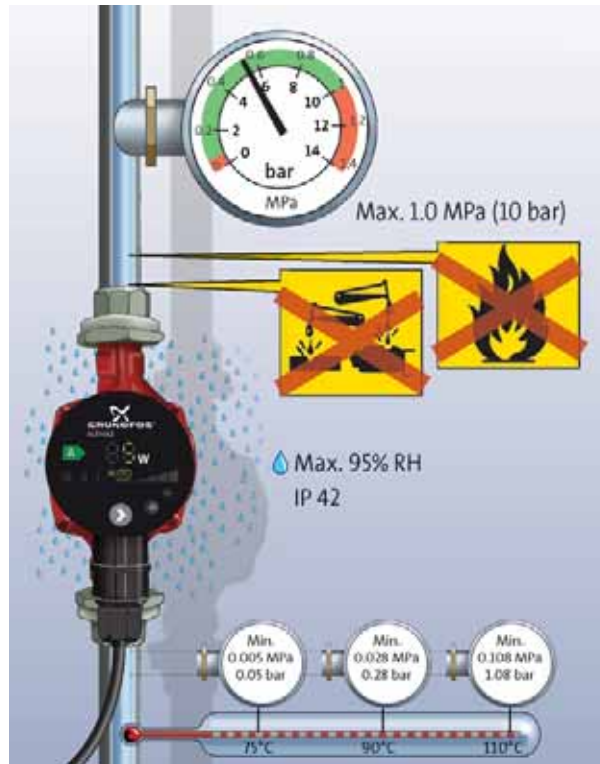

Fig. 2 Pumped liquids and operating conditions

GRUNDFOS ALPHA2 is suitable for

- systems with **constant** or **variable flows** where it is desirable to optimise the setting of the pump duty point
- systems with **variable flow-pipe temperature**
- systems where night setback is desired.

3.2 Pumped liquids

Clean, thin, non-aggressive and non-explosive liquids, not containing solid particles, fibres or mineral oil. See fig. 2.

In **heating systems**, the water should meet the requirements of accepted standards on water quality in heating systems, e.g. the German standard VDI 2035.

In **domestic hot-water systems**, it is advisable to use GRUNDFOS ALPHA2 pumps only for water with a degree of hardness lower than approx. 14 °dH. For water with a higher degree of hardness, a direct-coupled TPE pump is recommended.



Warning

The pump must not be used for the transfer of flammable liquids such as diesel oil, petrol and similar liquids.

3.3 System pressure

Maximum 1.0 MPa (10 bar). See fig. 2.

3.4 Relative air humidity (RH)

Maximum 95 %. See fig. 2.

3.5 Enclosure class

IP 42. See fig. 2.

3.6 Inlet pressure

Minimum inlet pressure in relation to liquid temperature. See fig. 2.

Liquid temperature	Minimum inlet pressure	
	[MPa]	[bar]
≤ 75 °C	0.005	0.05
90 °C	0.028	0.28
110 °C	0.108	1.08

4. Installation

Contents:

[4.1 Mounting](#)

[4.2 Control box positions](#)

[4.3 Changing the control box position](#)

[4.4 Insulation of pump housing.](#)

4.1 Mounting

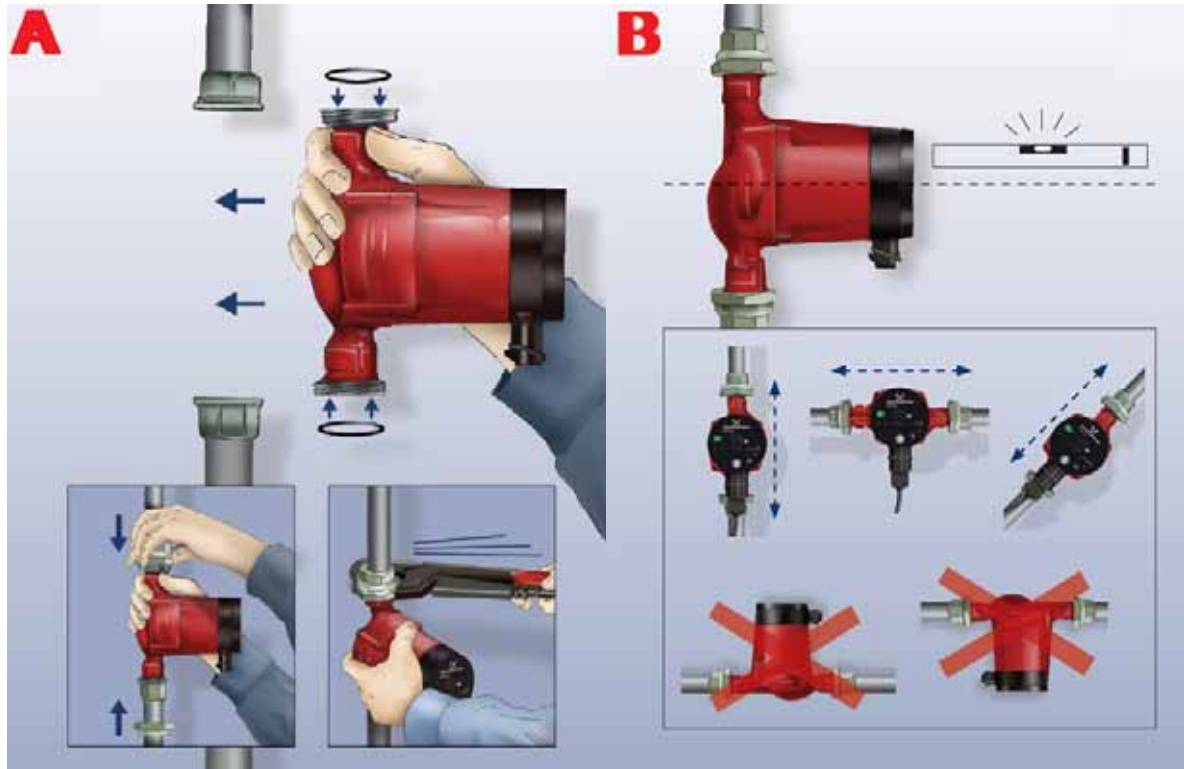

Fig. 3 Mounting the GRUNDFOS ALPHA2

Arrows on the pump housing indicate the liquid flow direction through the pump.

See [13.2 Installation dimensions – GRUNDFOS ALPHA2 XX-40, XX-50, XX-60](#) or [13.3 Installation dimensions – GRUNDFOS ALPHA2 25-40 A, 25-60 A](#).

1. Fit the two gaskets supplied when the pump is mounted in the pipe. See fig. 3, pos. A.
2. Install the pump with the motor shaft horizontal. See fig. 3, pos. B.

4.2 Control box positions

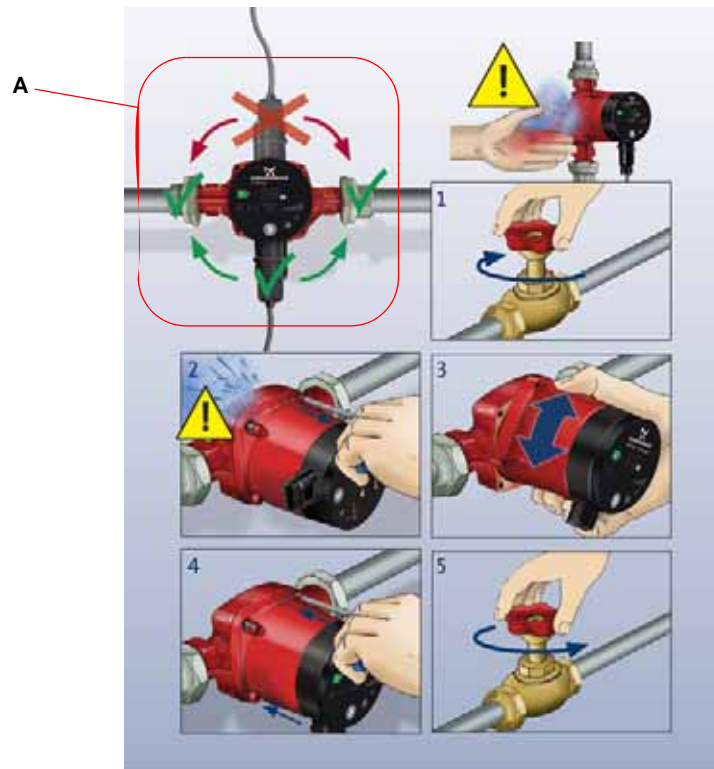

Fig. 4 Control box positions



Warning

The pumped liquid may be scalding hot and under high pressure! Drain the system or close the isolating valves on either side of the pump before the screws are removed.



When the position of the control box has been changed, fill the system with the liquid to be pumped or open the isolating valves.

4.3 Changing the control box position

The control box can be rotated in steps of 90 °.

Possible/permissible positions and the procedure of changing the position of the control box are illustrated in fig. 4, pos. A.

Procedure:

1. Slacken and remove the four hexagon-socket head screws holding the pump head with a tee key (M4).
2. Turn the pump head to the desired position.
3. Insert and cross-tighten the screws.

4.4 Insulation of pump housing



Fig. 5 Insulation of pump housing

Note

Limit the heat loss from the pump housing and pipework.

The heat loss from the pump and pipework can be reduced by insulating the pump housing and the pipe. See fig. 5.

As an alternative, polystyrene insulation shells can be ordered from Grundfos. See 16. *Accessories*.

Caution

Do not insulate the control box or cover the control panel.

TM03 8924 2707

5. Electrical connection



Fig. 6 Electrical connection

The electrical connections and protection must be carried out in accordance with local regulations.

Warning



The pump must be connected to earth .

The pump must be connected to an external mains switch with a minimum contact gap of 3 mm in all poles.

- The motor requires no external motor protection.
- Check that the supply voltage and frequency correspond to the values stated on the pump. See [15.1 Nameplate](#).
- Connect the pump to the mains with the plug supplied with the pump as shown in fig. 6, steps 1 to 8.
- Light in the control panel shows that the electricity supply has been switched on.

6. Control panel

Contents:

[6.1 Elements on the control panel](#)

[6.2 Display](#)

[6.3 Light fields indicating the pump setting](#)

[6.4 Light field indicating the status of Automatic Night SetBack](#)

[6.5 Push-button for activation of Automatic Night SetBack](#)

[6.6 Push-button for selection of pump setting.](#)

6.1 Elements on the control panel

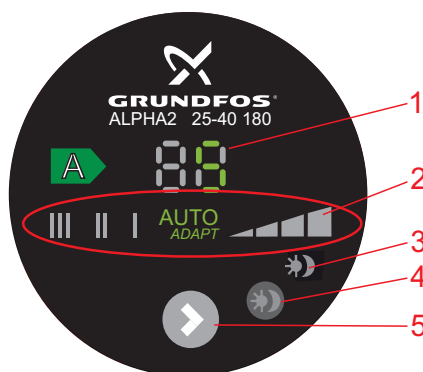

Fig. 7 GRUNDFOS ALPHA2 control panel

The control panel on the GRUNDFOS ALPHA2 comprises:

Pos.	Description
1	Display showing the actual pump power consumption in Watt
2	Eight light fields indicating the pump setting
3	Light field indicating the status of Automatic Night SetBack
4	Push-button for activation of Automatic Night SetBack
5	Push-button for SELECTION of pump setting

6.2 Display

The display, pos. 1, is on when the electricity has been switched on.

The display shows the actual pump power consumption in Watt (integer) during operation.

Faults preventing the pump from operating properly (e.g. seizing-up) are indicated in the display by "- -".

If a fault is indicated, correct the fault and reset the pump by switching the electricity supply off and on.

TM03 8919 2707

6.3 Light fields indicating the pump setting

GRUNDFOS ALPHA2 has eight optional settings which can be selected with the push-button. See fig. 7, pos. 5.

The pump setting is indicated by eight different light fields. See fig. 8.

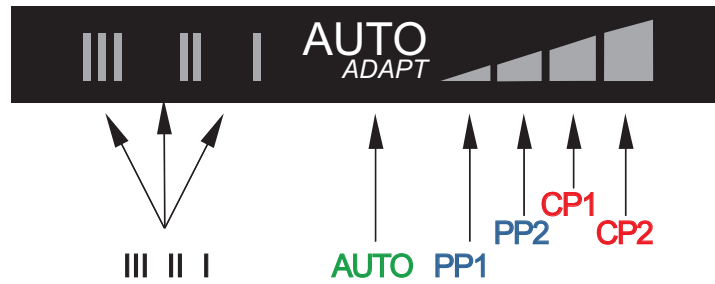

TM03 8926 2707

Fig. 8 Eight light fields

Button presses	Light field	Description
0	AUTOADAPT (factory setting)	AUTOADAPT
1	PP1	Lowest proportional-pressure curve
2	PP2	Highest proportional-pressure curve
3	CP1	Lowest constant-pressure curve
4	CP2	Highest constant-pressure curve
5	III	Constant curve, speed III
6	II	Constant curve, speed II
7	I	Constant curve, speed I
8	AUTOADAPT	AUTOADAPT

See [11. Pump settings and pump performance](#) for information about the function of the settings.

6.4 Light field indicating the status of Automatic Night SetBack

Light in , see fig. 7, pos. 3, shows that Automatic Night SetBack is active.

See [6.5 Push-button for activation of Automatic Night SetBack](#).

6.5 Push-button for activation of Automatic Night SetBack

The push-button, see fig. 7, pos. 4, activates/deactivates Automatic Night SetBack.

Automatic Night SetBack is only relevant for heating systems prepared for this function. See [8. Automatic Night SetBack](#).

The light field , see fig. 7, pos. 3, is on when Automatic Night SetBack is active.

Factory setting: Automatic Night SetBack = not active.

Note *If the pump has been set to speed I, II or III, it is not possible to select Automatic Night SetBack.*

6.6 Push-button for selection of pump setting

Every time the push-button is pressed, see fig. 7, pos. 5, the pump setting is changed.

A cycle is eight button presses. See [6.3 Light fields indicating the pump setting](#).

7. Setting the pump

Contents:

[7.1 Pump setting for system type](#)

[7.2 Pump control.](#)

7.1 Pump setting for system type

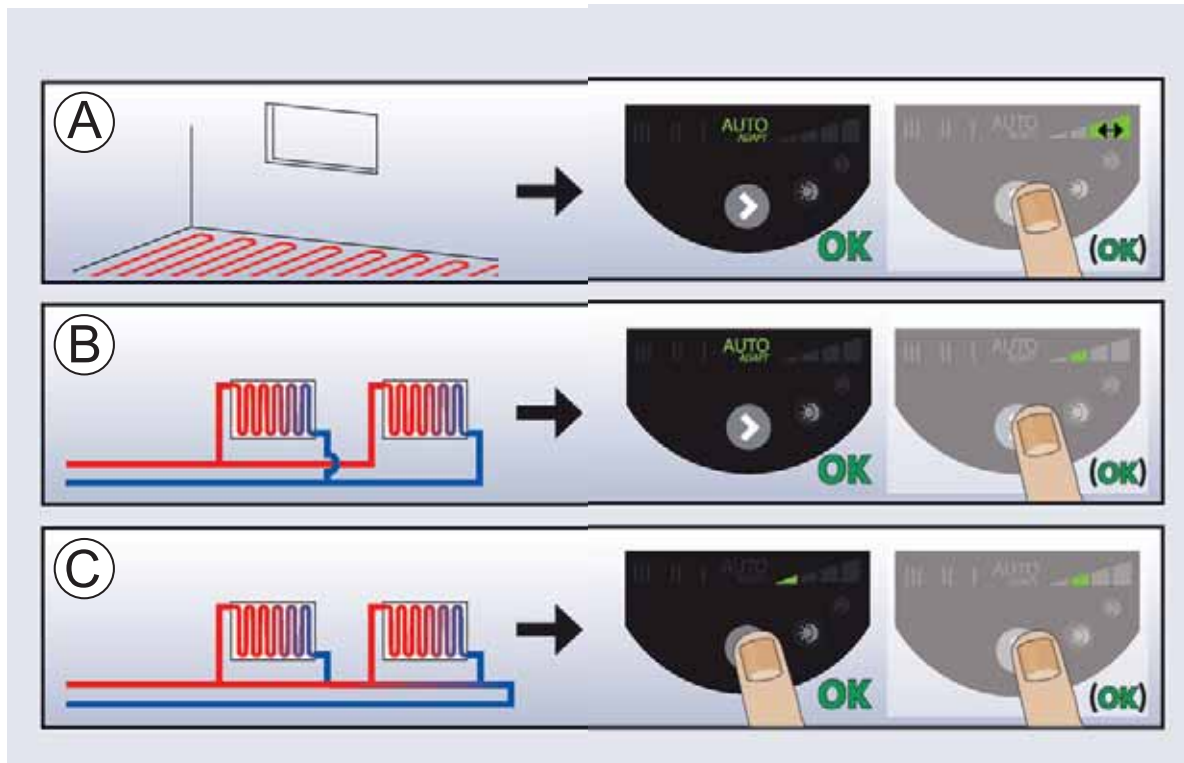

Fig. 9 Selection of pump setting for system type

Factory setting = **AUTOADAPT**.

Recommended and alternative pump settings according to fig. 9:

Pos.	System type	Pump setting	
		Recommended	Alternative
A	Underfloor heating	AUTOADAPT*	Highest constant-pressure curve (CP2)* or lowest constant-pressure curve (CP1)*
B	Two-pipe systems	AUTOADAPT*	Highest proportional-pressure curve (PP2)*
C	One-pipe systems	Lowest proportional-pressure curve (PP1)*	Highest proportional-pressure curve (PP2)*

* See [14.1 Guide to performance curves](#).

AUTOADAPT (underfloor heating and two-pipe systems)

The AUTOADAPT function adjusts the pump performance to the actual heat demand in the system. As the performance is adjusted gradually, it is recommended to leave the pump in the AUTOADAPT position at least one week before changing the pump setting.

If you choose to change back to AUTOADAPT, the pump remembers its last setpoint in AUTOADAPT and resumes the automatic adjustment of the performance.

Changing from recommended to alternative pump setting

Heating systems are "slow" systems that cannot be set to the optimum operation within minutes or hours.

If the recommended pump setting does not give the desired distribution of heat in the rooms of the house, change the pump setting to the shown alternative.

Explanation to pump settings in relation to performance curves, see [11. Pump settings and pump performance](#).

7.2 Pump control

During operation, the pump head will be controlled according to the principle "proportional-pressure control" (PP) or "constant-pressure control" (CP).

In these control modes, the pump performance and consequently the power consumption are adjusted according to the heat demand in the system.

Proportional-pressure control

In this control mode, the differential pressure across the pump is controlled according to the flow.

The proportional-pressure curves are indicated by PP1 and PP2 in the Q/H diagrams. See [11. Pump settings and pump performance](#).

Constant-pressure control

In this control mode, a constant differential pressure across the pump is maintained, irrespective of the flow.

The constant-pressure curves are indicated by CP1 and CP2 and are the horizontal performance curves in the Q/H diagrams. See [11. Pump settings and pump performance](#).

8. Automatic Night SetBack

Contents:

[8.1 Basis for Automatic Night SetBack](#)

[8.2 Function of Automatic Night SetBack.](#)

8.1 Basis for Automatic Night SetBack

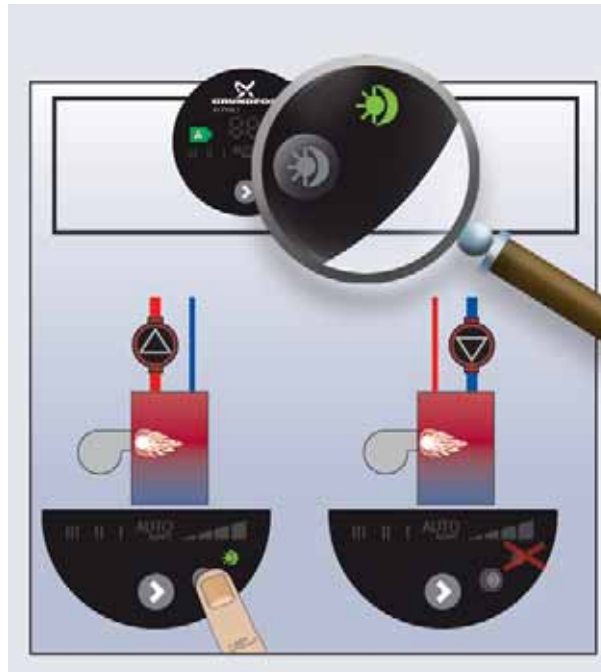

Fig. 10 Automatic Night SetBack



Warning

Pumps built into gas boilers with a small water content must never be set to Automatic Night SetBack.

Note

If speed I, II or III is selected, the Automatic Night SetBack is deactivated.

Note

It is necessary to reactivate Automatic Night SetBack if the electricity supply has been switched off.

Note

If the heating system is "undersupplied" (insufficient heat), check whether Automatic Night SetBack is activated. If yes, deactivate this function.

To ensure the optimum function of Automatic Night SetBack, the following conditions must be fulfilled:

- The pump must be installed in the flow pipe.
The Automatic Night SetBack function does not work if the pump is installed in the return pipe.
- The system (boiler) must incorporate automatic control of the liquid temperature.

Activate Automatic Night SetBack by pressing .

See [6.5 Push-button for activation of Automatic Night SetBack](#).

Light in  shows that Automatic Night SetBack is active.

TM03 8929 2707

8.2 Function of Automatic Night SetBack

Once Automatic Night SetBack has been activated, the pump changes automatically between normal duty and night setback. See [11. Pump settings and pump performance](#).

Changeover between normal duty and night setback is dependent on the flow-pipe temperature.

The pump automatically changes over to night setback when a flow-pipe temperature drop of more than 10-15 °C within approx. 2 hours is registered. The temperature drop must be at least 0.1 °C/min.

Changeover to normal duty takes place without a time lag when the flow-pipe temperature has increased by approx. 10 °C.

9. Systems with bypass valve between flow and return pipes

Contents:

[9.1 Purpose of bypass valve](#)

[9.2 Manually operated bypass valve](#)

[9.3 Automatic bypass valve \(thermostatically controlled\).](#)

9.1 Purpose of bypass valve

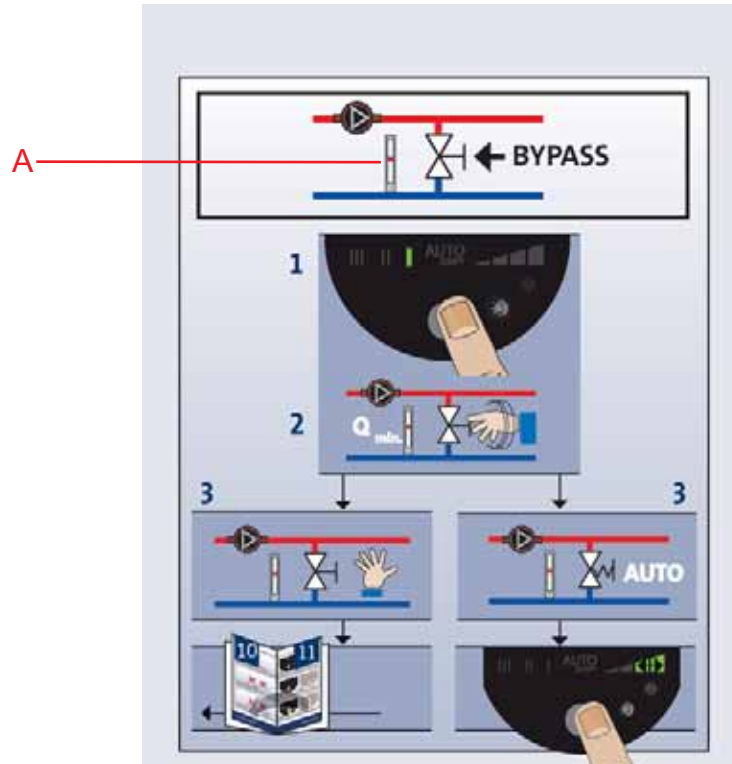

Fig. 11 Systems with bypass valve

Bypass valve

The purpose of the bypass valve is to ensure that the heat from the boiler can be distributed when all valves in the underfloor-heating circuits and/or thermostatic radiator valves are closed.

System elements:

- bypass valve
- flowmeter, pos. A.

The minimum flow must be present when all valves are closed.

The pump setting depends on the type of bypass valve used, i.e. manually operated or thermostatically controlled.

9.2 Manually operated bypass valve

Follow this procedure:

1. Adjust the bypass valve with the pump in setting I (speed I). The minimum flow (Q_{min}) for the system must always be observed. Consult the manufacturer's instructions.
2. When the bypass valve has been adjusted, set the pump according to [7. Setting the pump](#).

TM03 8928 2707

9.3 Automatic bypass valve (thermostatically controlled)

Follow this procedure:

1. Adjust the bypass valve with the pump in setting I (speed I).
The minimum flow ($Q_{\min.}$) for the system must always be observed.
Consult the manufacturer's instructions.
2. When the bypass valve has been adjusted, set the pump to the lowest or highest constant-pressure curve.
Explanation to pump settings in relation to performance curves, see [11. Pump settings and pump performance](#).

10. Start-up

Contents:

[10.1 Before start-up](#)

[10.2 Venting the pump](#)

[10.3 Venting of heating systems.](#)

10.1 Before start-up

Do not start the pump until the system has been filled with liquid and vented. The required minimum inlet pressure must be available at the pump inlet. See [3. Applications](#) and [13. Technical data and installation dimensions](#).

10.2 Venting the pump

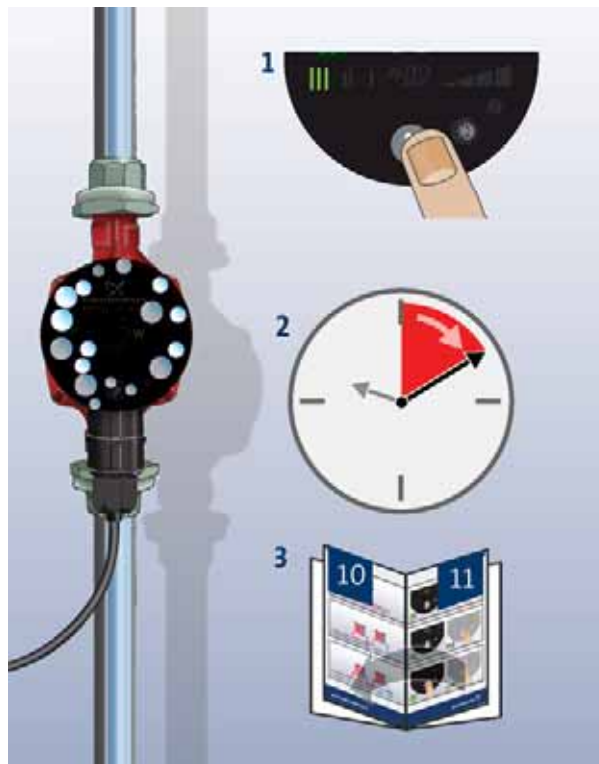

Fig. 12 Venting the pump

The pump is self-venting. It need not be vented before start-up.

Air in the pump may cause noise. This noise ceases after a few minutes running.

Quick venting of the pump can be obtained by setting the pump to speed III for a short period, depending on system size and design.

When the pump has been vented, i.e. when the noise has ceased, set the pump according to the recommendations. See [7. Setting the pump](#).

Caution *The pump must not run dry.*

The system cannot be vented through the pump. See [10.3 Venting of heating systems](#).

TMD3 8930 2707

10.3 Venting of heating systems

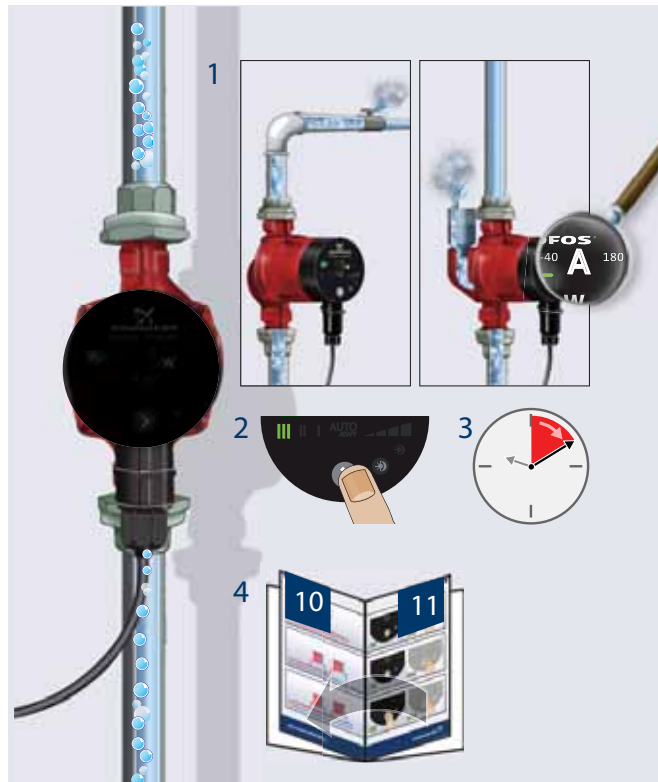

Fig. 13 Venting of heating systems

The heating system can be vented

- via an air escape valve installed above the pump (1)
- via a pump housing with air separator (2).

In heating systems that often contain much air, Grundfos recommends the installation of pumps with pump housing with air separator, i.e. ALPHA2 pumps, type ALPHA2 XX-XX A.

When the heating system has been filled with liquid, follow this procedure:

1. Open the air escape valve.
2. Set the pump to speed III.
3. Let the pump run for a short period, depending on system size and design.
4. When the system has been vented, i.e. when the possible noise has ceased, set the pump according to the recommendations. See [7. Setting the pump.](#)

Repeat the procedure, if necessary.

Caution *The pump must not run dry.*

11. Pump settings and pump performance

Contents:

11.1 Relation between pump setting and pump performance.

11.1 Relation between pump setting and pump performance

Figure 14 shows the relation between pump setting and pump performance by means of curves. See also 14. Performance curves.

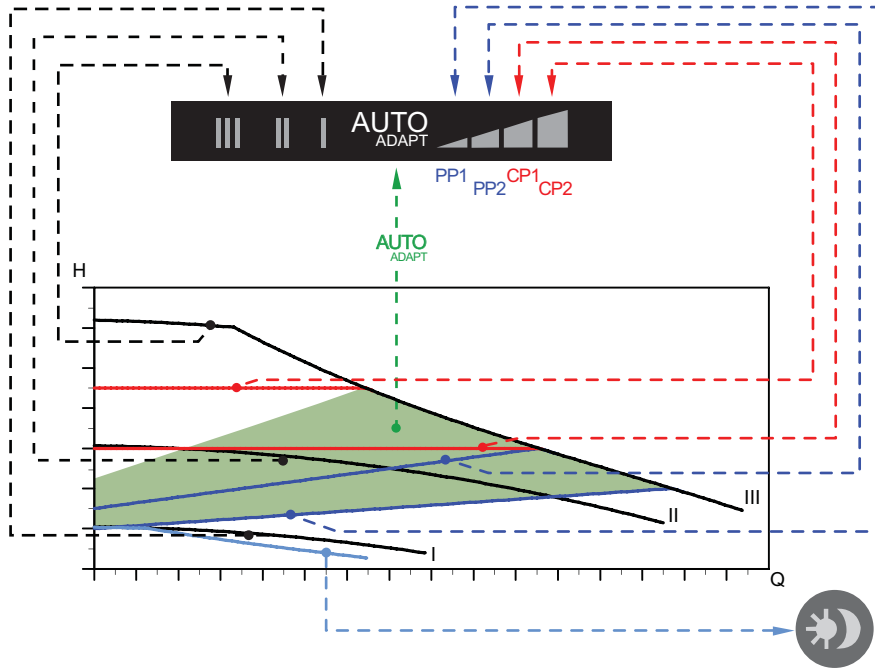



Fig. 14 Pump setting in relation to pump performance

TM03 9208 3607

Setting	Pump curve	Function
AUTO _{ADAPT} (factory setting)	Highest to lowest proportional-pressure curve	<p>The AUTO_{ADAPT} function enables ALPHA2 to control the pump performance automatically within a defined performance range, see fig. 14:</p> <ul style="list-style-type: none"> Adjusting the pump performance to the size of the system. Adjusting the pump performance to the variations in load over time. <p>In AUTO_{ADAPT}, the pump is set to proportional-pressure control.</p>
PP1	Lowest proportional-pressure curve	<p>The duty point of the pump will move up or down on the lowest proportional-pressure curve, see fig. 14, depending on the water demand.</p> <p>The head (pressure) is reduced at falling water demand and increased at rising water demand.</p>
PP2	Highest proportional-pressure curve	<p>The duty point of the pump will move up or down on the highest proportional-pressure curve, see fig. 14, depending on the water demand.</p> <p>The head (pressure) is reduced at falling water demand and increased at rising water demand.</p>
CP1	Lowest constant-pressure curve	<p>The duty point of the pump will move out or in on the lowest constant-pressure curve, see fig. 14, depending on the water demand in the system.</p> <p>The head (pressure) is kept constant, irrespective of the water demand.</p>
CP2	Highest constant-pressure curve	<p>The duty point of the pump will move out or in on the highest constant-pressure curve, see fig. 14, depending on the water demand in the system.</p> <p>The head (pressure) is kept constant, irrespective of the water demand.</p>

Setting	Pump curve	Function
III	Speed III	ALPHA2 runs at a constant speed and consequently on a constant curve. In speed III, the pump is set to run on the max. curve under all operating conditions. See fig. 14. Quick venting of the pump can be obtained by setting the pump to speed III for a short period. See 10.2 Venting the pump .
II	Speed II	ALPHA2 runs at a constant speed and consequently on a constant curve. In speed II, the pump is set to run on the medium curve under all operating conditions. See fig. 14.
I	Speed I	ALPHA2 runs at a constant speed and consequently on a constant curve. In speed I, the pump is set to run on the min. curve under all operating conditions. See fig. 14.
		ALPHA2 changes to the curve for Automatic Night SetBack, i.e. absolute minimum performance and power consumption, provided certain conditions are met. See 8. Automatic Night SetBack .

12. Fault finding chart



Warning

Before starting any work on the pump, make sure that the electricity supply has been switched off and that it cannot be accidentally switched on.

Fault	Control panel	Cause	Remedy
1. The pump does not run.	Light off.	a) One fuse in the installation is blown.	Replace the fuse.
		b) The current-operated or voltage-operated circuit breaker has tripped out.	Cut in the circuit breaker.
		c) The pump is defective.	Replace the pump.
	Shows "- -".	a) Electricity supply failure. Might be too low.	Check that the electricity supply falls within the specified range.
		b) The pump is blocked.	Remove the impurities.
2. Noise in the system.	Shows a number.	a) Air in the system.	Vent the system. See 10.3 Venting of heating systems .
		b) The flow is too high.	Reduce the suction head. See 11. Pump settings and pump performance .
3. Noise in the pump.	Shows a number.	a) Air in the pump.	Let the pump run. It vents itself over time. See 10.2 Venting the pump .
		b) The inlet pressure is too low.	Increase the inlet pressure or check the air volume in the expansion tank, if installed.
4. Insufficient heat.	Shows a number.	a) The pump performance is too low.	Increase the suction head. See 11. Pump settings and pump performance .

13. Technical data and installation dimensions

Contents:

[13.1 Technical data](#)

[13.2 Installation dimensions – GRUNDFOS ALPHA2 XX-40, XX-50, XX-60](#)

[13.3 Installation dimensions – GRUNDFOS ALPHA2 25-40 A, 25-60 A.](#)

13.1 Technical data

Supply voltage	1 x 230 V – 10 %/+ 6 %, 50 Hz, PE	
Motor protection	The pump requires no external motor protection.	
Enclosure class	IP 42	
Insulation class	F	
Relative air humidity	Maximum 95 %	
System pressure	Maximum 1.0 MPa, 10 bar, 102 m head	
Inlet pressure	Liquid temperature	Minimum inlet pressure
	≤+75 °C	0.05 bar, 0.005 MPa, 0.5 m head
	+90 °C	0.28 bar, 0.028 MPa, 2.8 m head
	+110 °C	1.08 bar, 0.108 MPa, 10.8 m head
EMC	EN 61000-6-2 and EN 61000-6-3	
Sound pressure level	The sound pressure level of the pump is lower than 43 dB(A).	
Ambient temperature	0 °C to +40 °C	
Temperature class	TF110 to CEN 335-2-51	
Surface temperature	The maximum surface temperature will not exceed +125°C.	
Liquid temperature	+2 °C to +110 °C	

To avoid condensation in the control box and stator, the liquid temperature must always be higher than the ambient temperature.

Ambient temperature [°C]	Liquid temperature	
	Min. [°C]	Max. [°C]
0	2	110
10	10	110
20	20	110
30	30	110
35	35	90
40	40	70

Caution

In domestic hot-water systems, it is recommended to keep the liquid temperature below 65 °C to eliminate the risk of lime precipitation.

13.2 Installation dimensions – GRUNDFOS ALPHA2 XX-40, XX-50, XX-60

Dimensional sketches and table of dimensions.

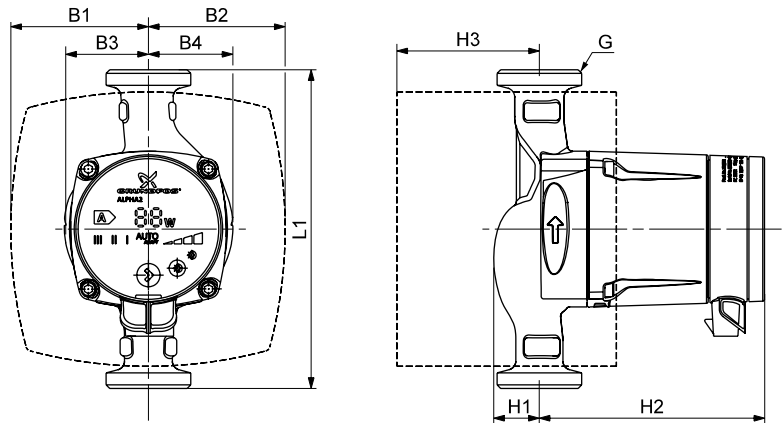

Fig. 15 Dimensional sketches, ALPHA2 XX-40, XX-50, XX-60

TM03 9215 3607

Pump type	Dimensions								
	L1	B1	B2	B3	B4	H1	H2	H3	G
ALPHA2 15-40 130	130	77	78	46	49	27	129	79	1
ALPHA2 15-50 (N) 130*	130	77	78	46	49	27	129	79	1 1/2
ALPHA2 25-40 130	130	77	78	46	49	27	129	79	1 1/2
ALPHA2 25-40 (N) 180	180	78	77	47	48	26	127	81	1 1/2
ALPHA2 32-40 180	180	78	77	47	48	26	127	81	2
ALPHA2 15-60 130	130	77	78	46	49	27	129	79	1**
ALPHA2 25-60 130	130	77	78	46	49	27	129	79	1 1/2
ALPHA2 25-60 (N) 180	180	78	77	47	48	26	127	81	1 1/2
ALPHA2 32-60 180	180	78	77	47	48	26	127	81	2

*) For the UK market only. **) For UK 1 1/2.

13.3 Installation dimensions – GRUNDFOS ALPHA2 25-40 A, 25-60 A

Dimensional sketches and table of dimensions.

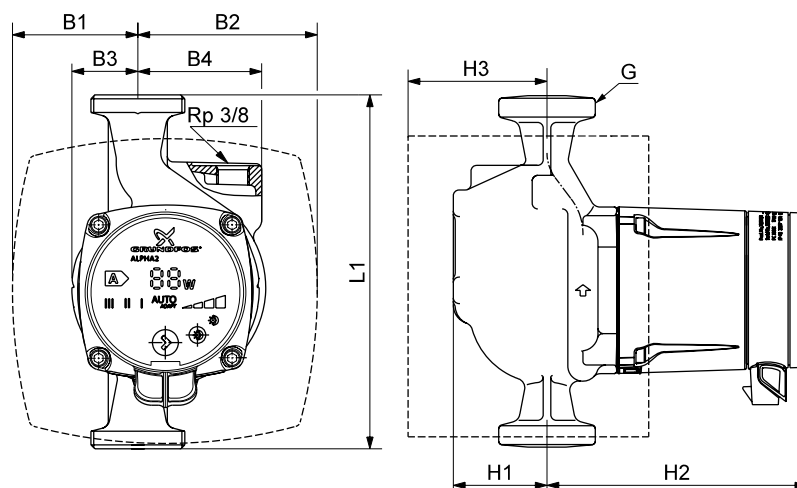

Fig. 16 Dimensional sketches, ALPHA2 25-40 A, 25-60 A

TM03 9211 3607

Pump type	Dimensions								
	L1	B1	B2	B3	B4	H1	H2	H3	G
ALPHA2 25-40 A 180	180	64	91	34	65	50	137	71	1 1/2
ALPHA2 25-60 A 180	180	64	91	34	65	50	137	71	1 1/2

14. Performance curves

Contents:

[14.1 Guide to performance curves](#)

[14.2 Curve conditions](#)

[14.3 Performance curves, ALPHA2 XX-40](#)

[14.4 Performance curves, ALPHA2 XX-50](#)

[14.5 Performance curves, ALPHA2 XX-60.](#)

14.1 Guide to performance curves

Each pump setting has its own performance curve (Q/H curve). However, *AUTOADAPT* covers a performance range.

A power curve (P1 curve) belongs to each Q/H curve. The power curve shows the pump power consumption (P1) in Watt at a given Q/H curve.

The P1 value corresponds to the value that can be read from the pump display, see fig. 17:

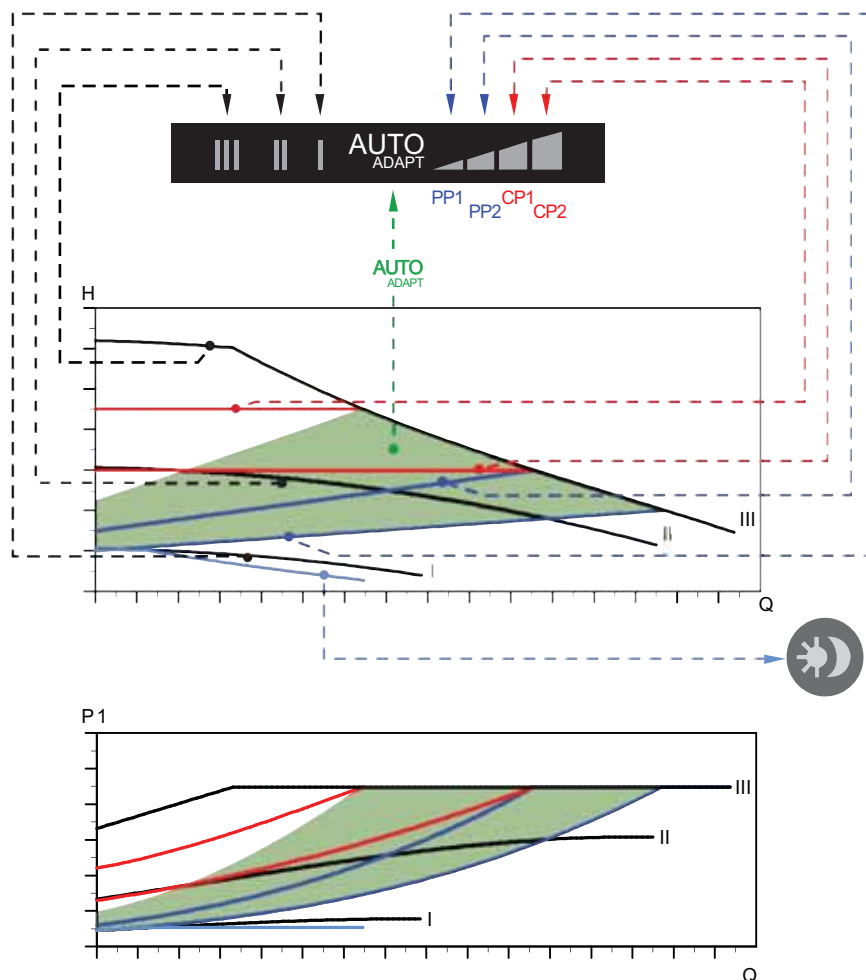



Fig. 17 Performance curves in relation to pump setting

Setting	Pump curve
<i>AUTOADAPT</i> (factory setting)	Setpoint within the green marked area
PP1	Lowest proportional-pressure curve
PP2	Highest proportional-pressure curve
CP1	Lowest constant-pressure curve
CP2	Highest constant-pressure curve
III	Constant speed, speed III
II	Constant speed, speed II
I	Constant speed, speed I
	Curve for Automatic Night SetBack

For further information about pump settings, see

[6.3 Light fields indicating the pump setting](#)

[7. Setting the pump](#)

[11. Pump settings and pump performance.](#)

TM03 9161 3507

14.2 Curve conditions

The guidelines below apply to the curves on the next pages:

- Test liquid: Airless water.
- The curves apply to a density of $\rho = 983.2 \text{ kg/m}^3$ and a liquid temperature of $+60 \text{ }^\circ\text{C}$.
- All curves show average values and should not be used as guarantee curves. If a specific minimum performance is required, individual measurements must be made.
- The curves for speeds I, II and III are marked.
- The curves apply to a kinematic viscosity of $\nu = 0.474 \text{ mm}^2/\text{s}$ (0.474 cSt).

14.3 Performance curves, ALPHA2 XX-40

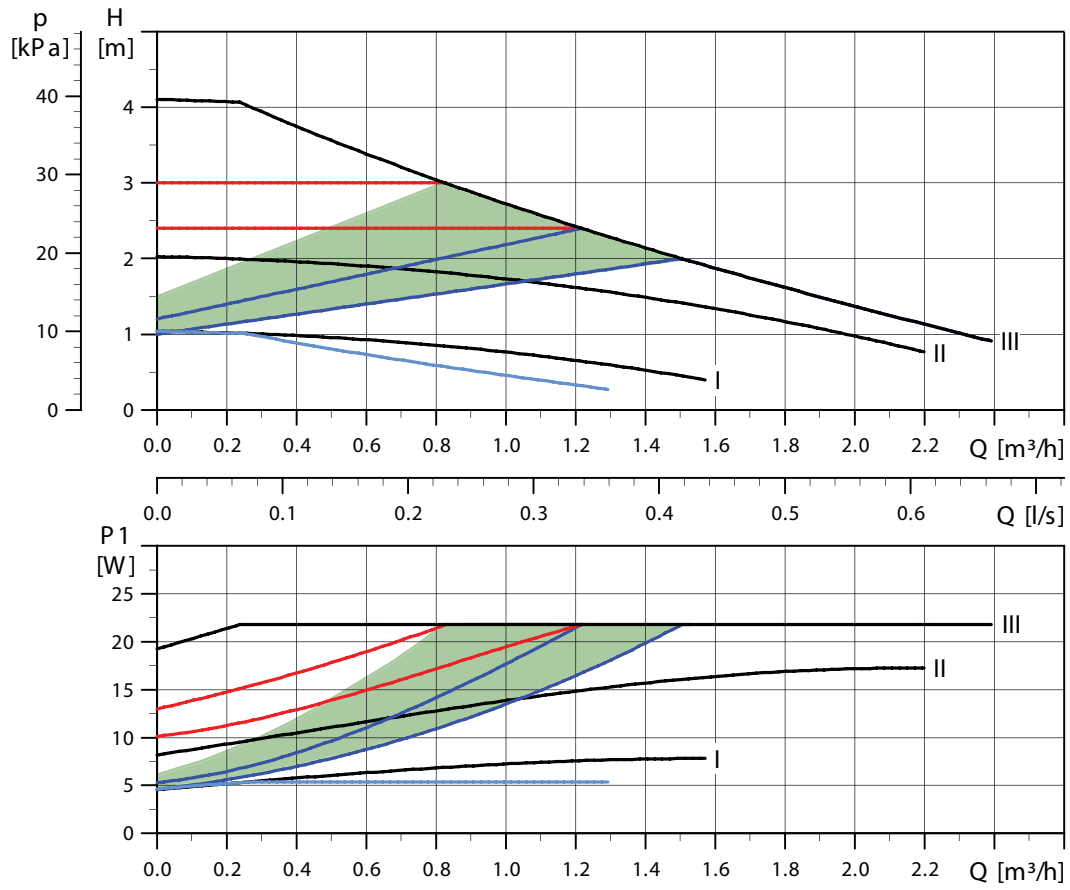

Fig. 18 Performance curves, ALPHA2 XX-40

TM03 9083 3307

14.4 Performance curves, ALPHA2 XX-50

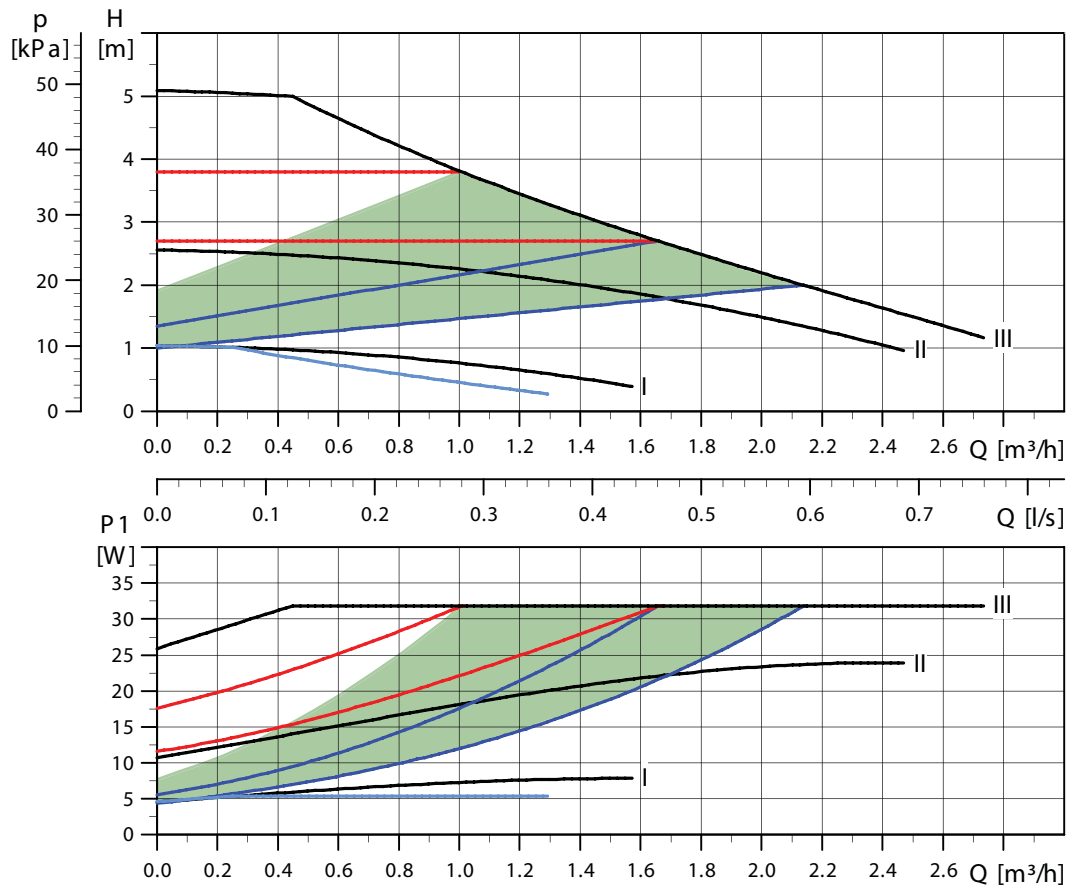

Fig. 19 Performance curves, ALPHA2 XX-50

TMD3 9084 3307

14.5 Performance curves, ALPHA2 XX-60

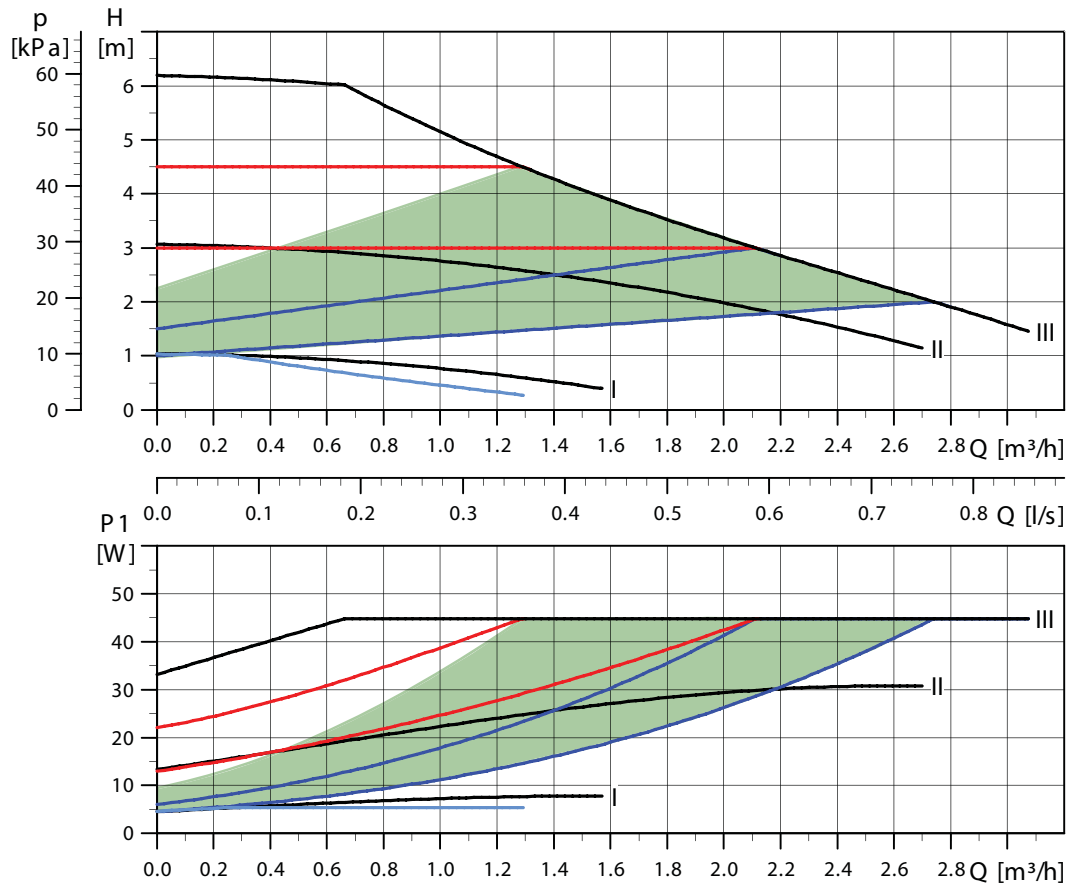

Fig. 20 Performance curves, ALPHA2 XX-60

TM03 9085 3307

15. Features

Contents:

[15.1 Nameplate](#)

[15.2 Type key.](#)

15.1 Nameplate

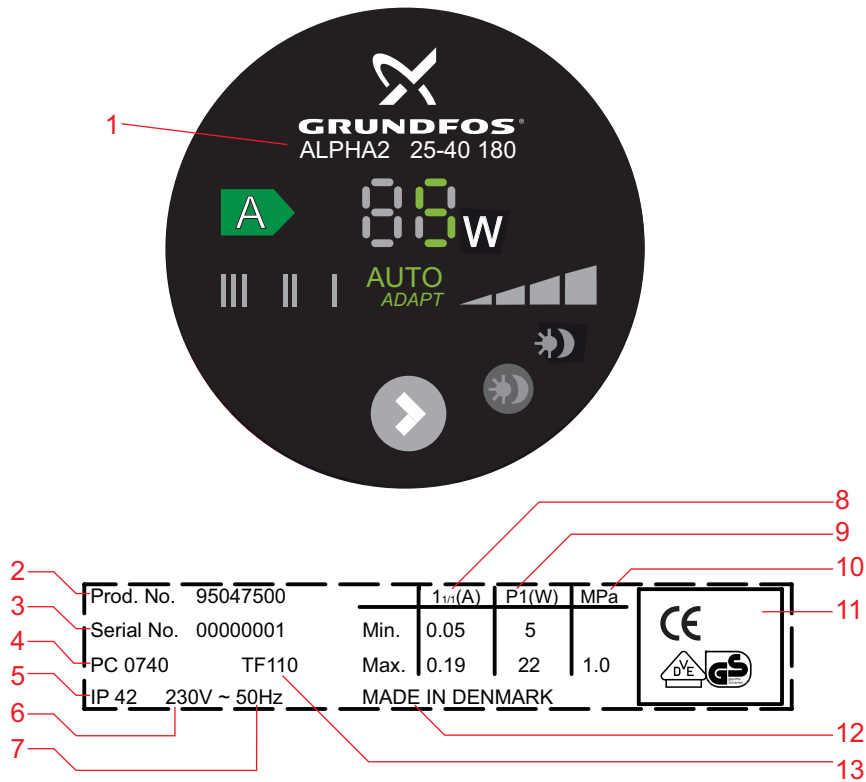

Fig. 21 Nameplate, GRUNDFOS ALPHA2

Pos.	Description	Pos.	Description
1	Pump type	8	Rated current [A]: • Min.: Minimum current [A] • Max.: Maximum current [A]
2	Product number	9	Input power P ₁ [W]: • Min.: Minimum input power P ₁ [W] • Max.: Maximum input power P ₁ [W]
3	Serial number	10	Maximum system pressure [MPa]
4	Production code • 1st and 2nd figures = year • 3rd and 4th figures = week	11	CE mark and approvals
5	Enclosure class	12	Country of origin
6	Voltage [V]	13	Temperature class
7	Frequency [Hz]		

TM03 9155 3507

15.2 Type key

Example	ALPHA2	25	-40	N	180
Pump type					
Nominal diameter (DN) of suction and discharge ports [mm]					
Maximum head [dm]					
-: Cast-iron pump housing A: Pump housing with air separator N: Stainless-steel pump housing					
Port-to-port length [mm]					

16. Accessories



Fig. 22 Accessories

Accessories for GRUNDFOS ALPHA2. See fig. 22.

Accessories include

- fittings (unions and valves)
- insulation kits (insulation shells)
- plug.

TM03 8932 2707

17. Disposal

This product or parts of it must be disposed of in an environmentally sound way:

1. Use the public or private waste collection service.
2. If this is not possible, contact the nearest Grundfos company or service workshop.

Argentina

Bombas GRUNDFOS de Argentina S.A.
Ruta Panamericana km. 37.500 Lote
34A
1619 - Garin
Pcia. de Buenos Aires
Phone: +54-3327 414 444
Telefax: +54-3327 411 111

Australia

GRUNDFOS Pumps Pty. Ltd.
P.O. Box 2040
Regency Park
South Australia 5942
Phone: +61-8-8461-4611
Telefax: +61-8-8340 0155

Austria

GRUNDFOS Pumpen Vertrieb
Ges.m.b.H.
Grundfosstraße 2
A-5082 Grödig/Salzburg
Tel.: +43-6246-883-0
Telefax: +43-6246-883-30

Belgium

N.V. GRUNDFOS Bellux S.A.
Boomsesteenweg 81-83
B-2630 Aartselaar
Tél.: +32-3-870 7300
Télécopie: +32-3-870 7301

Belorussia

Представительство ГРУНДФОС в
Минске
220090 Минск ул.Олешева 14
Телефон: (8632) 62-40-49
Факс: (8632) 62-40-49

Bosnia/Herzegovina

GRUNDFOS Sarajevo
Paromlinska br. 16,
BiH-71000 Sarajevo
Phone: +387 33 713290
Telefax: +387 33 231795

Brazil

Mark GRUNDFOS Ltda.
Av. Humberto de Alencar Castelo
Branco, 630
CEP 09850 - 300
São Bernardo do Campo - SP
Phone: +55-11 4393 5533
Telefax: +55-11 4343 5015

Bulgaria

GRUNDFOS Pumpen Vertrieb
Representative Office - Bulgaria
Bulgaria, 1421 Sofia
Lozenetz District
105-107 Arsenalski Blvd.
Phone: +359 2963 3820, 2963 5653
Telefax: +359 2963 1305

Canada

GRUNDFOS Canada Inc.
2941 Brighton Road
Oakville, Ontario
L6H 6C9
Phone: +1-905 829 9533
Telefax: +1-905 829 9512

China

GRUNDFOS Pumps (Shanghai) Co. Ltd.
51 Floor, Raffles City
No. 268 Xi Zang Road. (M)
Shanghai 200001
PRC
Phone: +86-021-612 252 22
Telefax: +86-021-612 253 33

Croatia

GRUNDFOS predstavništvo Zagreb
Cebini 37, Buzin
HR-10000 Zagreb
Phone: +385 1 6595 400
Telefax: +385 1 6595 499

Czech Republic

GRUNDFOS s.r.o.
Čajkovského 21
779 00 Olomouc
Phone: +420-585-716 111
Telefax: +420-585-716 299

Denmark

GRUNDFOS DK A/S
Martin Bachs Vej 3
DK-8850 Bjerringbro
Tlf.: +45-87 50 50 50
Telefax: +45-87 50 51 51
E-mail: info_GDK@grundfos.com
www.grundfos.com/DK

Estonia

GRUNDFOS Pumps Eesti OÜ
Peterburi tee 44
11415 Tallinn
Tel: + 372 606 1690
Fax: + 372 606 1691

Finland

OY GRUNDFOS Pumput AB
Mestarintie 11
FIN-01730 Vantaa
Phone: +358-3066 5650
Telefax: +358-3066 56550

France

Pompes GRUNDFOS Distribution S.A.
Parc d'Activités de Chesnes
57, rue de Malacombe
F-38290 St. Quentin Fallavier (Lyon)
Tél.: +33-4 74 82 15 15
Télécopie: +33-4 74 94 10 51

Germany

GRUNDFOS GMBH
Schlüterstr. 33
40699 Erkrath
Tel.: +49-(0) 211 929 69-0
Telefax: +49-(0) 211 929 69-3799
e-mail: infoservice@grundfos.de
Service in Deutschland:
e-mail: kundendienst@grundfos.de

Greece

GRUNDFOS Hellas A.E.B.E.
20th km. Athinon-Markopoulou Av.
P.O. Box 71
GR-19002 Peania
Phone: +0030-210-66 83 400
Telefax: +0030-210-66 46 273

Hong Kong

GRUNDFOS Pumps (Hong Kong) Ltd.
Unit 1, Ground floor
Siu Wai Industrial Centre
29-33 Wing Hong Street &
68 King Lam Street, Cheung Sha Wan
Kowloon
Phone: +852-27861706 / 27861741
Telefax: +852-27858664

Hungary

GRUNDFOS Hungária Kft.
Park u. 8
H-2045 Törökbálint,
Phone: +36-23 511 110
Telefax: +36-23 511 111

India

GRUNDFOS Pumps India Private Limited
118 Old Mahabalipuram Road
Thoraipakkam
Chennai 600 096
Phone: +91-44 2496 6800

Indonesia

PT GRUNDFOS Pompa
Jl. Rawa Sumur III, Blok III / CC-1
Kawasan Industri, Pulogadung
Jakarta 13930
Phone: +62-21-460 6909
Telefax: +62-21-460 6910 / 460 6901

Ireland

GRUNDFOS (Ireland) Ltd.
Unit A, Merrywell Business Park
Ballymount Road Lower
Dublin 12
Phone: +353-1-4089 800
Telefax: +353-1-4089 830

Italy

GRUNDFOS Pompe Italia S.r.l.
Via Gran Sasso 4
I-20060 Truccazzano (Milano)
Tel.: +39-02-95838112
Telefax: +39-02-95309290 / 95838461

Japan

GRUNDFOS Pumps K.K.
Gotanda Metalion Bldg., 5F,
5-21-15, Higashi-gotanda
Shiagawa-ku, Tokyo
141-0022 Japan
Phone: +81 35 448 1391
Telefax: +81 35 448 9619

Korea

GRUNDFOS Pumps Korea Ltd.
6th Floor, Aju Building 679-5
Yeoksam-dong, Kangnam-ku, 135-916
Seoul, Korea
Phone: +82-2-5317 600
Telefax: +82-2-5633 725

Latvia

SIA GRUNDFOS Pumps Latvia
Deglava biznesa centrs
Augusta Deglava ielā 60, LV-1035, Rīga,
Tālr.: + 371 714 9640, 7 149 641
Fakss: + 371 914 9646

Lithuania

GRUNDFOS Pumps UAB
Smolensko g. 6
LT-03201 Vilnius
Tel: + 370 52 395 430
Fax: + 370 52 395 431

Malaysia

GRUNDFOS Pumps Sdn. Bhd.
7 Jalan Peguam U1/25
Glenmarie Industrial Park
40150 Shah Alam
Selangor
Phone: +60-3-5569 2922
Telefax: +60-3-5569 2866

México

Bombas GRUNDFOS de México S.A. de
C.V.
Boulevard TLC No. 15
Parque Industrial Stiva Aeropuerto
Apodaca, N.L. 66600
Phone: +52-81-8144 4000
Telefax: +52-81-8144 4010

Netherlands

GRUNDFOS Netherlands
Veluwezoom 35
1326 AE Almere
Postbus 22015
1302 CA ALMERE
Tel.: +31-88-478 6336
Telefax: +31-88-478 6332
e-mail: info_gnl@grundfos.com

New Zealand

GRUNDFOS Pumps NZ Ltd.
17 Beatrice Tinsley Crescent
North Harbour Industrial Estate
Albany, Auckland
Phone: +64-9-415 3240
Telefax: +64-9-415 3250

Norway

GRUNDFOS Pumper A/S
Strømsveien 344
Postboks 235, Leirdal
N-1011 Oslo
Tlf.: +47-22 90 47 00
Telefax: +47-22 32 21 50

Poland

GRUNDFOS Pompy Sp. z o.o.
ul. Klonowa 23
Baranowo k. Poznania
PL-62-081 Przeźmierowo
Phone: (+48-61) 650 13 00
Telefax: (+48-61) 650 13 50

Portugal

Bombas GRUNDFOS Portugal, S.A.
Rua Calvet de Magalhães, 241
Apartado 1079
P-2770-153 Paço de Arcos
Tel.: +351-21-440 76 00
Telefax: +351-21-440 76 90

România

GRUNDFOS Pompe România SRL
Bd. Biruintei, nr 103
Pantelimon county Ilfov
Phone: +40 21 200 4100
Telefax: +40 21 200 4101
E-mail: romania@grundfos.ro

Russia

ООО Грундфос
Россия, 109544 Москва, ул. Школьная
39
Тел. (+7) 495 737 30 00, 564 88 00
Факс (+7) 495 737 75 36, 564 88 11
E-mail
grundfos.moscow@grundfos.com

Serbia

GRUNDFOS Predstavništvo Beograd
Dr. Milutina Ivkovića 2a/29
YU-11000 Beograd
Phone: +381 11 26 47 877 / 11 26 47
496
Telefax: +381 11 26 48 340

Singapore

GRUNDFOS (Singapore) Pte. Ltd.
24 Tuas West Road
Jurong Town
Singapore 638381
Phone: +65-6865 1222
Telefax: +65-6861 8402

Slovenia

GRUNDFOS PUMPEN VERTRIEB
Ges.m.b.H.,
Podružnica Ljubljana
Blatnica 1, SI-1236 Trzin
Phone: +386 1 563 5338
Telefax: +386 1 563 2098
E-mail: slovenia@grundfos.si

Spain

Bombas GRUNDFOS España S.A.
Camino de la Fuentecilla, s/n
E-28110 Algete (Madrid)
Tel.: +34-91-848 8800
Telefax: +34-91-628 0465

Sweden

GRUNDFOS AB
Lunnagårdsgatan 6
431 90 Mölndal
Tel.: +46-0771-32 23 00
Telefax: +46-31 331 94 60

Switzerland

GRUNDFOS Pumpen AG
Bruggacherstrasse 10
CH-8117 Fällanden/ZH
Tel.: +41-1-806 8111
Telefax: +41-1-806 8115

Taiwan

GRUNDFOS Pumps (Taiwan) Ltd.
7 Floor, 219 Min-Chuan Road
Taichung, Taiwan, R.O.C.
Phone: +886-4-2305 0868
Telefax: +886-4-2305 0878

Thailand

GRUNDFOS (Thailand) Ltd.
947/168 Moo 12, Bangna-Trad Rd., K.M.
3,
Bangna, Phrakonong
Bangkok 10260
Phone: +66-2-744 1785 ... 91
Telefax: +66-2-744 1775 ... 6

Turkey

GRUNDFOS POMPA San. ve Tic. Ltd.
Sti.
Gebze Organize Sanayi Bölgesi
Ihsan dede Caddesi,
2. yol 200. Sokak No. 204
41490 Gebze/ Kocaeli
Phone: +90 - 262-679 7979
Telefax: +90 - 262-679 7905
E-mail: satis@grundfos.com

Ukraine

ТОВ ГРУНДФОС УКРАЇНА
01010 Київ, Вул. Московська 86,
Тел.:(+38 044) 390 40 50
факс: (+38 044) 390 40 59
E-mail: ukraine@grundfos.com

United Arab Emirates

GRUNDFOS Gulf Distribution
P.O. Box 16768
Jebel Ali Free Zone
Dubai
Phone: +971-4- 8815 166
Telefax: +971-4-8815 136

United Kingdom

GRUNDFOS Pumps Ltd.
Grovebury Road
Leighton Buzzard/Beds. LU7 8TL
Phone: +44-1525-850000
Telefax: +44-1525-850011

U.S.A.

GRUNDFOS Pumps Corporation
17100 West 118th Terrace
Olathe, Kansas 66061
Phone: +1-913-227-3400
Telefax: +1-913-227-3500

Uzbekistan

Представительство ГРУНДФОС в
Ташкенте
700000 Ташкент ул.Усмана Носира 1-й
тулик 5
Телефон: (3712) 55-68-15
Факс: (3712) 53-36-35

95047457 1107	GB

IMBOLD COM SRL
Str.Valea Cascadelor Expo Top Construct, sector 6,
Bucuresti, si Str.13 Decembrie Nr.140 Gaesti
Dambovita tel: 0757323528
www.centraleinstalatii.ro